



**CATALOGO PAVIMENTI E
RIVESTIMENTI MURALI
IN HDF 2023**

A close-up photograph of a wood cross-section, showing concentric growth rings in shades of light tan and beige. The rings are more pronounced in the center and become more subtle towards the edges.

TUTTO
IL LEGNO
CHE
AMIAMO

CATALOGO 2023



RIDISEGNA IL TUO AMBIENTE

Pavimenti eleganti e raffinati, esteticamente curati e di altissima qualità.

Prodotti solo con le migliori materie prime, creati perfettamente somiglianti al legno naturale ed ai materiali di maggiore tendenza del momento, piacevoli alla vista ed al tatto. Disponibili in una svariata gamma di materiali, dimensioni, decori e superfici.

Le nostre collezioni vengono scelte accuratamente per creare ambienti unici e con uno stile inconfondibile.

SOMMARIO

MATERIALI	8
Pavimenti in laminato (HDF)	8
Pavimenti in laminato ad alta resistenza (HDF O.R.C.A)	9
Pavimenti in laminato (HDF MO.RE!)	10
PAVIMENTI IN LAMINATO AD ALTA RESISTENZA (HDF O.R.C.A.)	12
Bionyl Pro	14



PAVIMENTI IN LAMINATO (HDF MO.RE!)	22
Altitude Collection	24
PAVIMENTI IN LAMINATO (HDF)	33
Vintage Classic	34
Mood	40
Natura Ac5	46
Exclusive 5G	52
Bella Neo	60



RIVESTIMENTI MURALI (MDF)	66
Shape	68
3D Wall	82
ACCESSORI DI FINITURA	90
Battiscopa in Legno laccato	92
Battiscopa in MDF/PVC rivestiti	96
Copri-battiscopa in MDF	99
Profili per Pavimenti in laminato (HDF)	102
Profili speciali	104
Sottofondi isolanti	106



LEGENDE	108
Legenda DOGHE/PIASTRE	108
Legenda CARATTERISTICHE	110
Legenda ICONE	112

PAVIMENTI IN LAMINATO (HDF)

Il pavimento in laminato in HDF (High Density Fiberboard) è un prodotto che si avvicina per estetica al parquet pur avendo delle caratteristiche che lo rendono molto spesso preferibile al legno, come ad esempio la facilità di posa, la resistenza allo sfregamento ed ai graffi, nessuna necessità di manutenzione ed un ottimo rapporto qualità-prezzo.

COM'È FATTO?

Composizione multistrato:

	HDF
01	STRATO SUPERFICIALE TRASPARENTE (OVERLAY) Disponibile in diversi spessori che rende il pavimento impermeabile e resistente a macchie, usura, graffi e bruciature.
02	STRATO DECORATIVO Realizzato in carta melaminica sulla quale viene stampata un'immagine fedele al legno reale.
01	PANNELLO CENTRALE Realizzato in HDF (High Density Fiberboard) antiumidità in diversi spessori. È composto da fibre di legno incollate, molto stabili nel tempo.
02	STRATO INFERIORE Composto da una controbilanciatura stabilizzante utile ad evitare la curvatura del pannello.

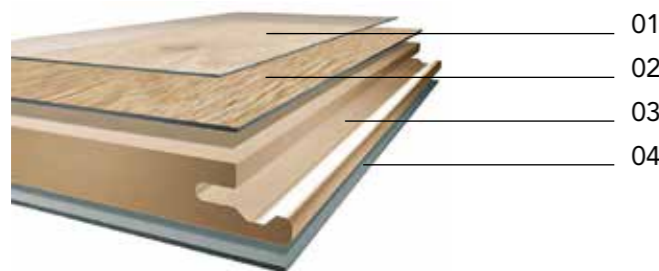

PAVIMENTI IN LAMINATO AD ALTA RESISTENZA (HDF O.R.C.A.)

Il pavimento in laminato ad altissima resistenza all'umidità.

O.R.C.A. è qualità al quadrato.

Unisce le migliori qualità dei pavimenti a base di fibre legnose a quelle dei pavimenti a base vinilica. In O.R.C.A., i materiali organici derivanti dalle fibre di legno sono resi resistenti ai liquidi mediante una tecnologia speciale.

O.R.C.A. rende BionylPRO utilizzabile ovunque.

L'innovativo pannello O.R.C.A. consente di installare BionylPRO anche nei bagni privati (si prega di osservare le istruzioni di installazione) dove, fino ad ora, potevano essere utilizzati solo pavimenti vinilici o piastrelle in ceramica. Inoltre, la sua eccezionale stabilità termica e la sua capacità di resistenza alla luce, rendono BionylPRO adatto anche ai giardini d'inverno e alle stanze con finestre o vetrate a tutta altezza.

O.R.C.A. è fatto meglio perché è fabbricato con un'innovativa tecnologia.

Le fibre di legno vengono lavorate meccanicamente più volte in uno speciale processo di produzione per ottenere particelle di fibre particolarmente piccole. Successivamente, nel processo di fabbricazione, un agente legante organicochimico appositamente sviluppato avvolge anche le fibre più minuscole e le isola dall'umidità.

COM'È FATTO?

Composizione multistrato:

	HDF O.R.C.A.
01	STRATO DI USURA FINO A 0,8 MM (31 MIL)
02	INNOVATIVO O.R.C.A. BOARD
03	O.R.C.A.
04	STRATO BILANCIANTE

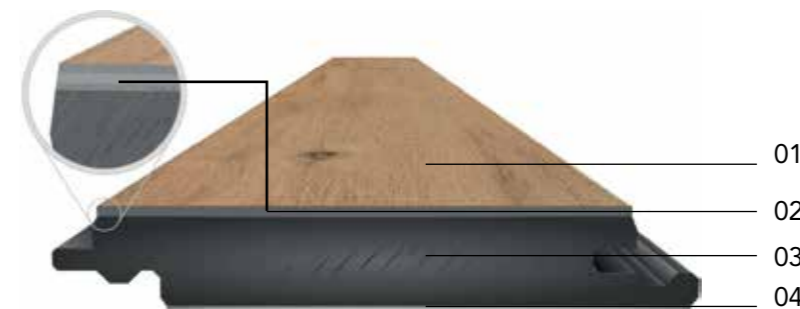

kronosspan

BIONYLPRO

O.R.C.A.®
ORGANIC RIGID COREBOARD ANTISTATIC
MOISTURE DEFENSE TECHNOLOGY



PAVIMENTI IN LAMINATO (HDF MO.RE!)

Take more. Endure more. Withstand more

Mo.RE! di KRONOSPAN è un pavimento in laminato resistente all'umidità, pratico, resistente, adatto alla vita di tutti i giorni. Dopotutto, piccole disavventure quotidiane possono capitare a chiunque.

Mo.Re! resiste a tutti gli inconvenienti:

- È molto più resistente all'umidità rispetto ai tradizionali pavimenti in laminato (fino a 48 h)
- La sua superficie antibatterica inibisce la crescita dei batteri sui pavimenti proteggendo la tua famiglia (Batteri testati: Staphylococcus aureus)
- È resistente alla luce: anche nei giorni in cui il sole splende per ore, la tua pavimentazione non subirà danni dalla luce solare
- Indicato per l'installazione anche in bagno.

Mo.re! si basa su una formula del supporto in Hdf appositamente sviluppata.

I nuovi leganti di cui è costituito il pannello rendono questo pavimento più resistente all'acqua riducendo il rigonfiamento.

Mo.re! offre di più. Anche per l'ambiente:

È realizzato utilizzando solo legno derivante da foreste gestite in modo sostenibile. I pavimenti a tecnologia Mo.Re! di KRONOSPAN non contengono PVC, a dimostrazione del proprio impegno per la tutela dell'ambiente.

La produzione del pannello Mo.re! è "CO₂ neutral":

durante il processo di trasformazione di un albero in pannello Hdf si fa in modo che questo prodotto emetta meno CO₂ di quanto l'albero abbia immagazzinato nella sua vita.

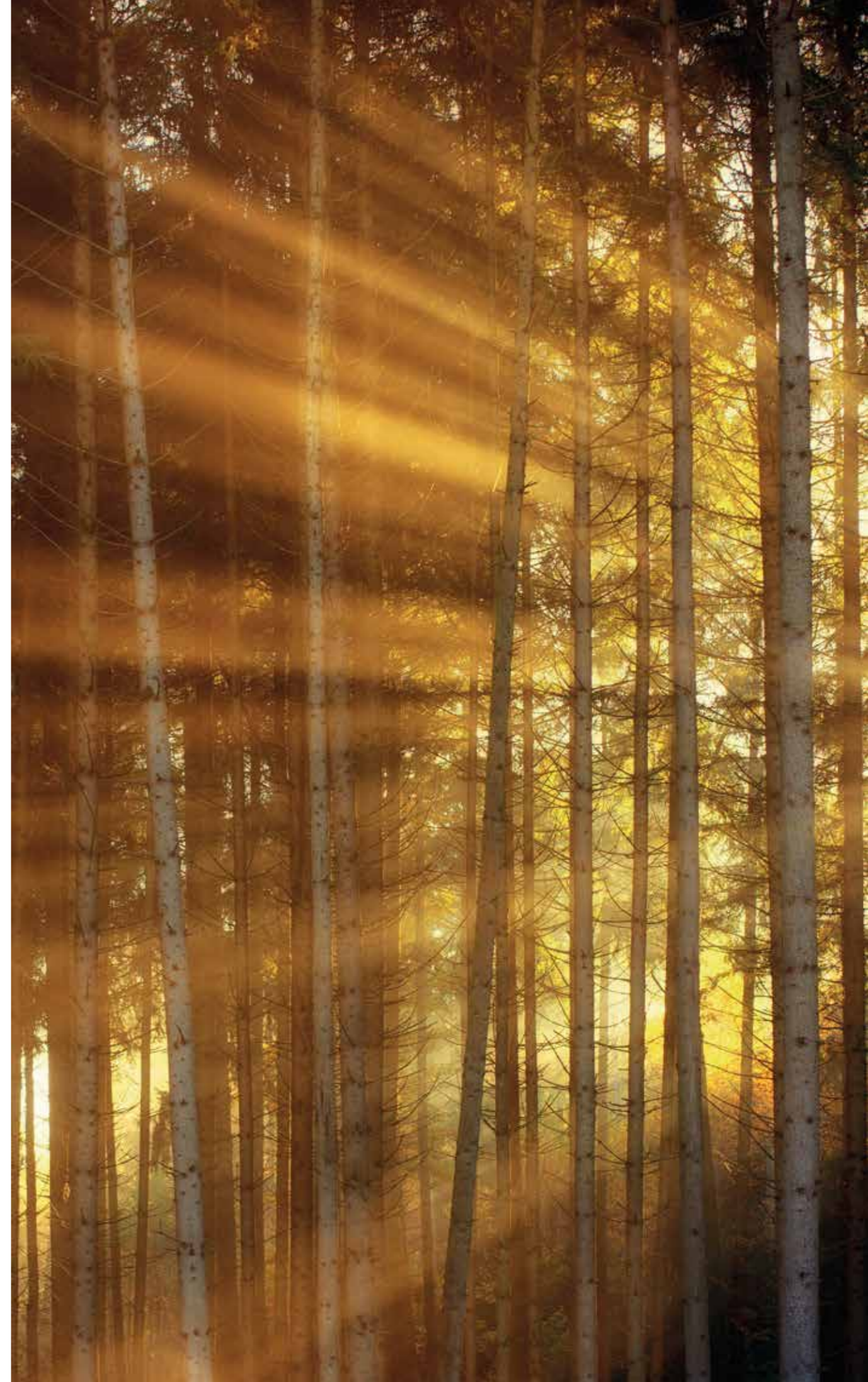

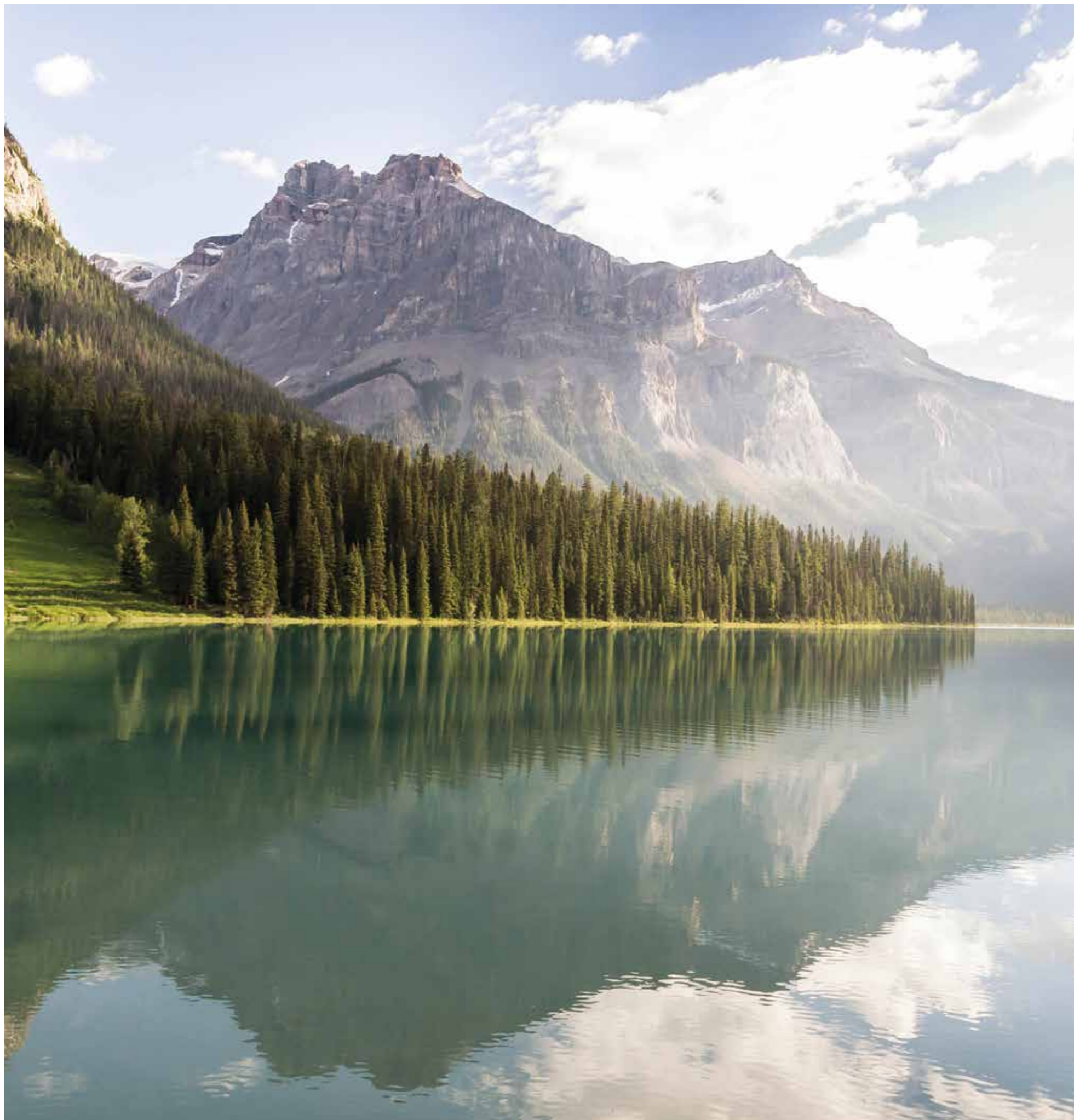

HDF O.R.C.A.

PAVIMENTI IN LAMINATO
AD ALTA RESISTENZA ALL'UMIDITÀ (HDF O.R.C.A.)

**RESISTENZA
ALL'ACQUA
CERTIFICATA
FINO A
100 ORE!**

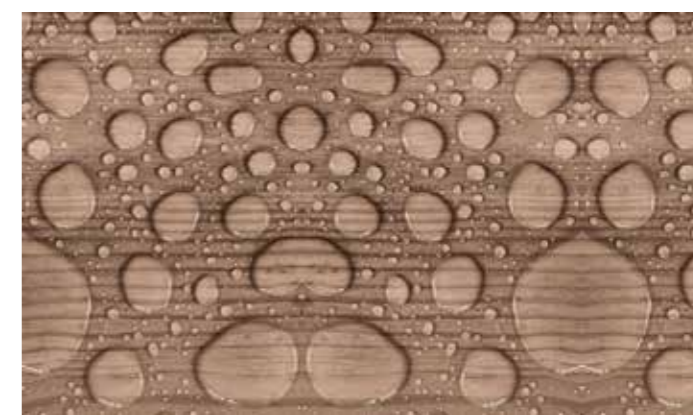

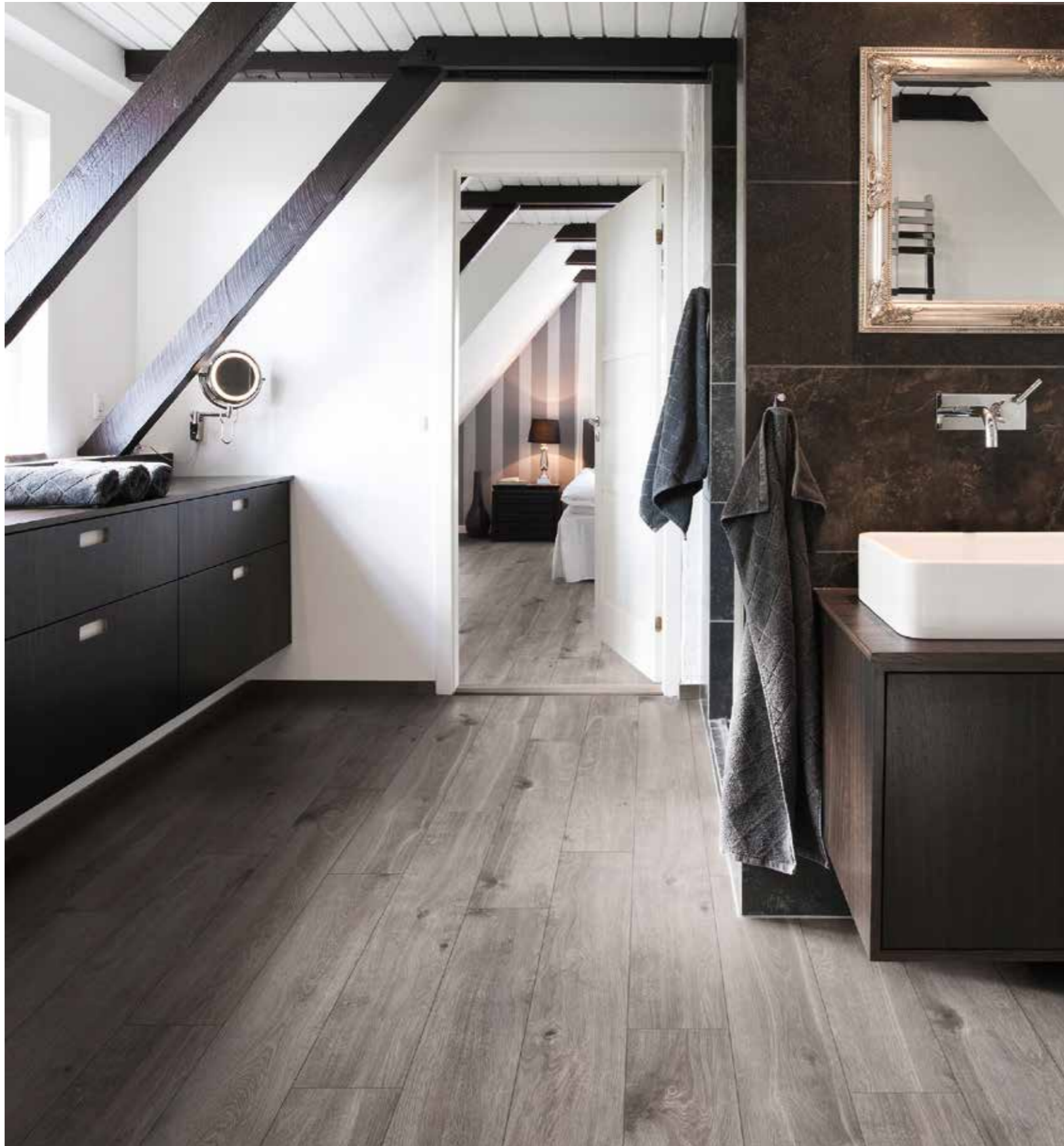

1531
Rovere Aramis

BIONYL PRO

PAVIMENTI IN LAMINATO
AD ALTA RESISTENZA ALL'UMIDITÀ (HDF O.R.C.A.)



BIONYL PRO	PAVIMENTO IN LAMINATO AD ALTA RESISTENZA ALL'UMIDITÀ (HDF O.R.C.A.)	BATTISCOPA COORDINATO (HDF ID.)
Dimensioni	1285 mm x 192 mm	2400 mm x 70 mm
Spessore	8 mm	15 mm
Confezione	2,22 mq	
Pedana	115,44 mq	



1519
Rovere Heirloom



1521
Rovere Tortona



1530
Rovere Dartagnan



1531
Rovere Aramis



1579
Rovere Havana

IL PAVIMENTO CHE RESISTE A TUTTO

RESISTENTE ALL'ACQUA

24 ore di protezione dagli spruzzi d'acqua secondo NALFA (North American Laminate Floor Association) ed oltre 100 ore di protezione secondo lo standard aziendale Kronospan WN-101, www.100hour-test.com

TERMICAMENTE STABILE

ANIMA BIOLOGICA

Costituito da legno naturale e legante chimico biologico.

CO₂ - NEUTRO

Pannelli CO₂ neutri perché il processo di produzione e di trasformazione di un albero in O.R.C.A. emette meno CO₂ di quanto l'albero stesso abbia immagazzinato.



1532
Rovere Bolero



1532
Rovere Bolero



1533
Rovere Hamilton



1579
Rovere Havana



1521
Rovere Tortona

CARATTERISTICHE

Classe di abrasione AC5. Classe di utilizzo: 23 - utilizzo domestico, intenso; 33 - utilizzo commerciale, intenso. Garantito 30 anni. A.B.C. anti-bacterial coating, antigraffio, antistatico, bordo bisellato su 4 lati, certificato al fuoco Bfl-s1, ecofriendly, emissioni in aria interna (VOC A+) Classe A+, installazione 1clic 2go pure, organic rigid board, pet friendly, resistente all'acqua, resistente alla luce, adatto al riscaldamento a pavimento, strato di usura 0,80 mm. Kronospan.

Altissima resistenza all'umidità.



kronospan

BIONYL PRO

O.R.C.A.
ORGANIC RIGID COREBOARD ANTISTATIC
MOISTURE DEFENSE TECHNOLOGY

DECORI
7 VARIANTI

BATTISCOPA
COORDINATO

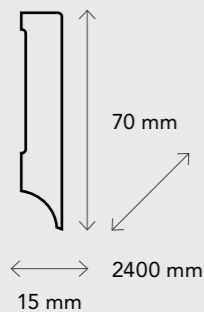

- 1519BND
Rovere Heirloom
- 1521BND
Rovere Tortona
- 1530BND
Rovere Dartagnan
- 1531BND
Rovere Aramis
- 1532BND
Rovere Bolero
- 1533BND
Rovere Hamilton
- 1579BND
Rovere Havana

ACCESSORI

Battiscopa coordinato
in HDF idrofugo
ad alta resistenza all'umidità.

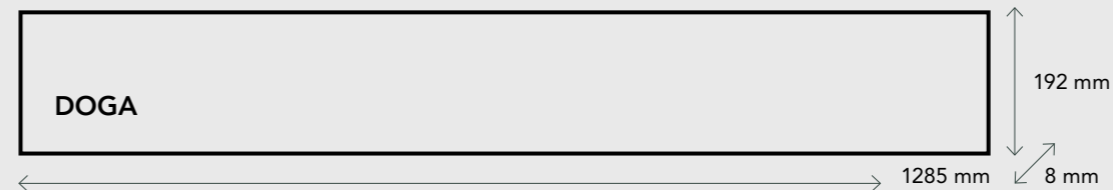



HDF MO.RE!

PAVIMENTI IN LAMINATO
(HDF MO.RE!)

RESISTENZA
ALL'ACQUA
CERTIFICATA
FINO A
48 ORE!





ALTITUDE COLLECTION

PAVIMENTI IN LAMINATO
(HDF MO.RE!)



5948AL
Rovere Reinassance

ALTITUDE COLLECTION	PAVIMENTI IN LAMINATO (HDF MO.RE!)	BATTISCOPIA COORDINATO (MDF)
Dimensioni	2000 mm x 242 mm	2400 mm x 80 mm
Spessore	12 mm	15 mm
Confezione	1,94 mq	
Pedana	69,84 mq	



5948AL
Rovere Reinassance



5954AL
Rovere Hardy



8155AL
Noce Appalachian



5954AL
Rovere Hardy



K326AL
Rovere Sundance



5953AL
Rovere Chantilly



K392AL
Atomic Oak



K326AL
Rovere Sundance



8155AL
Noce Appalachian



5953AL
Rovere Chantilly

**BATTISCOPA
COORDINATO**

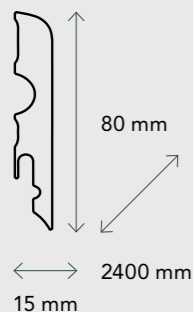

ACCESSORI

Battiscopa coordinato
in MDF



5948BN
Rovere Reinassance

5953BN
Rovere Chantilly

5954BN
Rovere Hardy

K326BN
Rovere Sundance

K392BN
Atomic Oak

8155BN
Noce Appalachian

CARATTERISTICHE

Classe di abrasione AC5. Classe di utilizzo: 23 - utilizzo domestico, intenso; 33 - utilizzo commerciale, intenso. Garantito 30 anni. A.B.C. anti-bacterial coating, antigraffio, antistatico, bordo bisellato su 4 lati, certificato al fuoco Cfl-s1, eco-friendly, effetto autentico, emissioni in aria interna (VOC A+) Classe A+, installazione clic 2go pure, adatto al riscaldamento a pavimento. Krono Original.

Doga maxi formato, ottima resistenza all'usura, design altamente realistico.



DECORI
6 VARIANTI

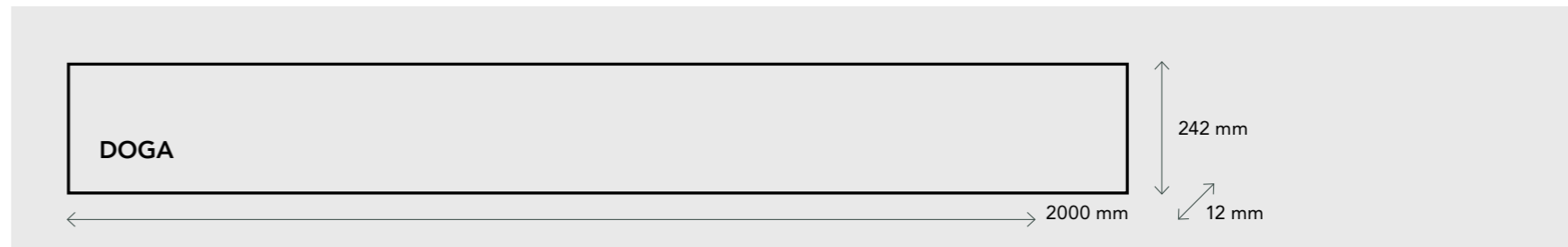



HDF

PAVIMENTI IN LAMINATO
(HDF)



VINTAGE CLASSIC

PAVIMENTI IN LAMINATO
(HDF)



UN'ALTRA EPOCA

CLASSICO ED ELEGANTE

I pavimenti "Vintage" offrono un design dal gusto classico ed elegante, proveniente da un'altra epoca. Una superficie opaca, con effetto piattato a mano ed una struttura sincrona, unita al particolare formato rende questo pavimento davvero speciale.

8155C
Noce Appalachian



5947C
Rovere Historic



8155C
Noce Appalachian



5953C
Rovere Chantilly



8156C
Noce Red River

VINTAGE CLASSIC	PAVIMENTI IN LAMINATO (HDF)	BATTISCOPIA COORDINATO (MDF)
Dimensioni	1285 mm x 192 mm	2400 mm x 80 mm
Spessore	10 mm	15 mm
Confezione	1,73 mq	
Pedana	89,96 mq	



5953C
Rovere Chantilly



5947C
Rovere Historic

CARATTERISTICHE

Classe di abrasione AC4. Classe di utilizzo: 23 - utilizzo domestico, intenso; 32 - utilizzo commerciale, normale. Garantito 30 anni. A.B.C. anti-bacterial coating, antigraffio, bordo bisellato su 4 lati, certificato al fuoco Cfl-s1, eco-friendly, effetto autentico, effetto piattato a mano, emissioni in aria interna (VOC A+) Classe A+, installazione 1 clic 2go pure, adatto al riscaldamento a pavimento. Krono Original.

Ottima resistenza all'usura, design classico e realistico.

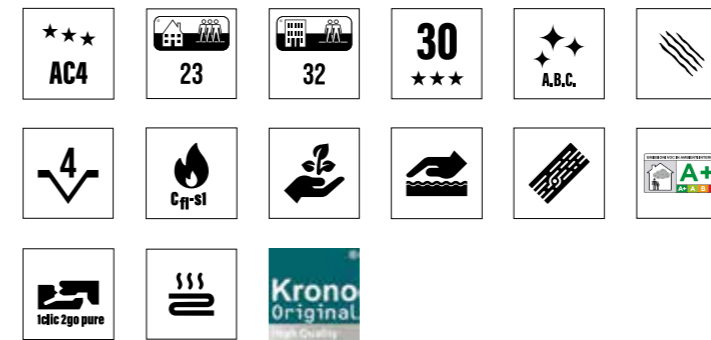

DECORI 4 VARIANTI



ACCESSORI

Battiscopa coordinato
in MDF

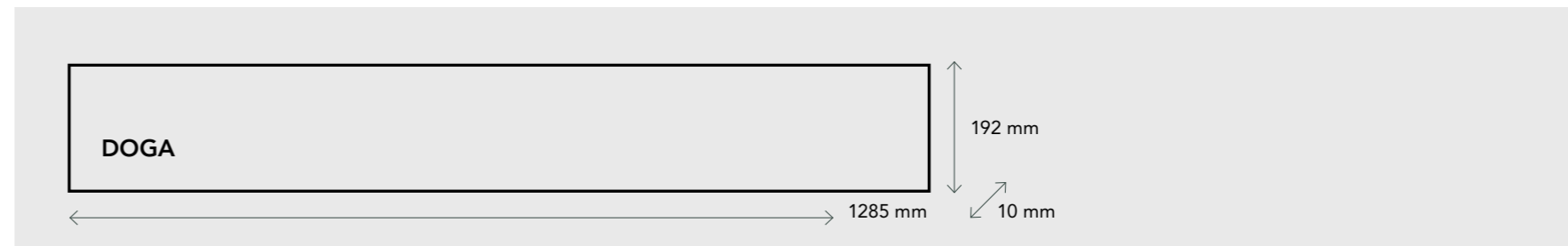

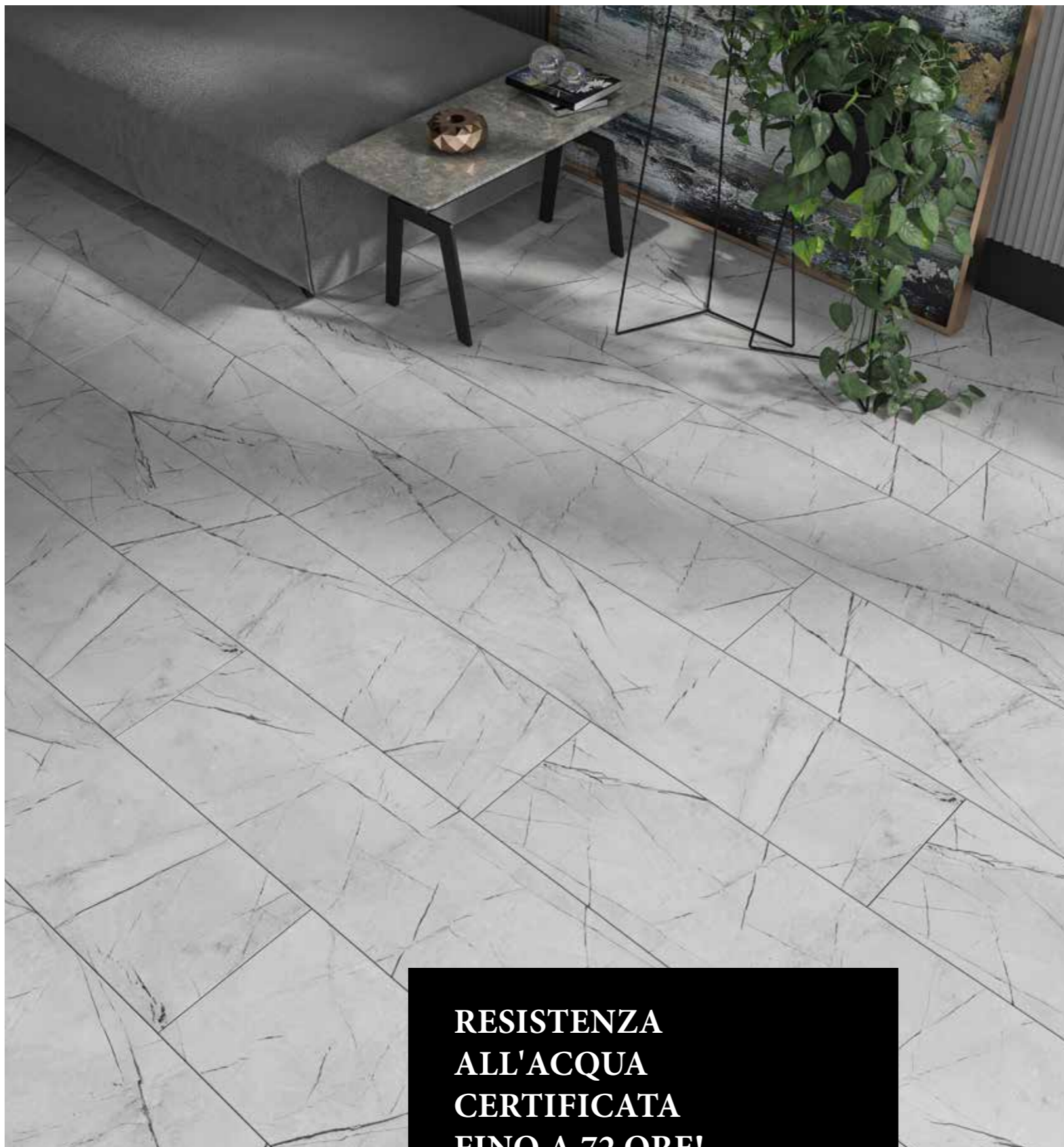

**RESISTENZA
ALL'ACQUA
CERTIFICATA
FINO A 72 ORE!**

PRK1001
Marine

MOOD

PAVIMENTI IN LAMINATO
(HDF)



MOOD	PAVIMENTI IN LAMINATO (HDF)	BATTISCOPIA COORDINATO (MDF)
Dimensioni	1195 mm x 325 mm	2400 mm x 80 mm
Spessore	10 mm	15 mm
Confezione	1,94 mq	
Pedana	104,76 mq	

PRK1001
Marine



PRK1002
Marvel



PRK1003
Malta



PRK1004
Mare



PRK1004
Mare



PRK1003
Malta



PRK1002
Marvel

CARATTERISTICHE

Classe di abrasione AC4. Classe di utilizzo: 23 - utilizzo domestico, intenso; 32 - utilizzo commerciale, normale. Garantito 30 anni. A.B.C. anti-bacterial coating, antigraffio, bordo bisellato su 4 lati, certificato al fuoco Cfl-s1, eco-friendly, effetto autentico, effetto piattato a mano, emissioni in aria interna (VOC A+) Classe A+, installazione 1 clic 2g pure, adatto al riscaldamento a pavimento.

Ottima resistenza all'usura, design classico e realistico.

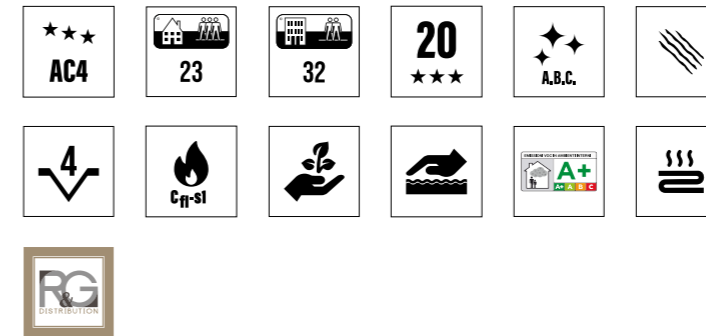

DECORI
4 VARIANTI

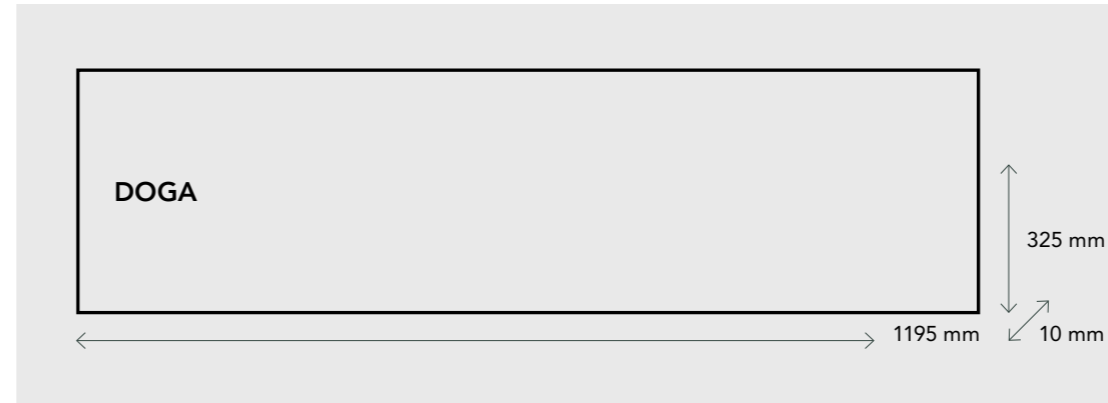
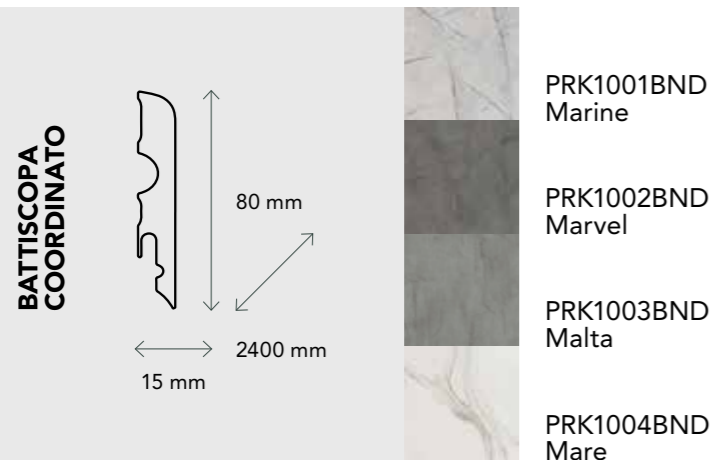

ACCESSORI

Battiscopa coordinato
in MDF



PRK504
Selge



PRK501
Trend Oak

NATURA AC5

PAVIMENTI IN LAMINATO
(HDF)



NATURA AC5	PAVIMENTI IN LAMINATO (HDF)	BATTISCOPIA COORDINATO (MDF)
Dimensioni	1200 mm x 191 mm	2800 mm x 80 mm
Spessore	8 mm	16 mm
Confezione	1,83 mq	
Pedana	109,80 mq	

PRK908
Altay



PRK506
Meriç



PRK504
Selge



PRK912
Solaro



PRK902
Tibet



PRK501
Trend Oak



PRK908
Altay



PRK902
Tibet



PRK506
Meriç

BATTISCOPA
COORDINATO

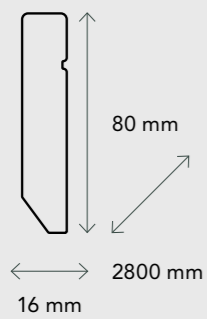

ACCESSORI

Battiscopa coordinato
in MDF

PRK908BN
Altay

PRK506BN
Meriç

PRK504BN
Selge

PRK912BN
Solaro

PRK902BN
Tibet

PRK501BN
Trend Oak

CARATTERISTICHE

Classe di abrasione AC5. Classe di utilizzo: 23 - utilizzo domestico, intenso; 33 - utilizzo commerciale, intenso. Garantito 20 anni. A.B.C. anti-bacterial coating, antigraffio, bordo bisellato su 4 lati, certificato al fuoco Cfl-s1, eco-friendly, emissioni in aria interna (VOC A+) Classe A+, adatto al riscaldamento a pavimento.

Ottima resistenza all'usura, bisellato sui 4 lati, design moderno ed accattivante.

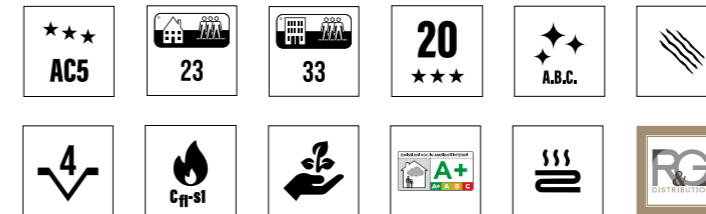

DECORI

6 VARIANTI

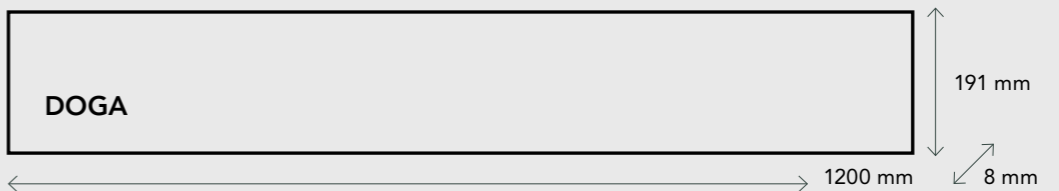

PRK912
Solaro



T2612
Ren



T2678
Unye

EXCLUSIVE 5G

PAVIMENTI IN LAMINATO
(HDF)



EXCLUSIVE 5G	PAVIMENTI IN LAMINATO (HDF)	BATTISCOPA COORDINATO (MDF)
Dimensioni	1204 mm x 193 mm	2400 mm x 80 mm
Spessore	8 mm	15 mm
Confezione	2,32 mq	
Pedana	120,64 mq	

T2669
Ural



T2678
Unye



T2622
Rio



T2643
Retro Silver



T2644
Retro Stone



T2612
Ren



T2644
Retro Stone



T2622
Rio

T2684
Mudania



T2682
Inebolu



T2638
Giza



T2670
Arkansas



T2684
Mudania



T2670
Arkansas



T2682
Inebolu



T2669
Ural



T2638
Giza

**BATTISCOPA
COORDINATO**

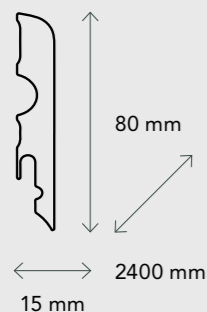

ACCESSORI

Battiscopa coordinato
in MDF



T2669BN
Ural

T2678BN
Unye

T2622BN
Rio

T2643BN
Retro Silver

T2644BN
Retro Stone



T2612BN
Ren

T2684BN
Mudanya

T2682BN
Inebolu

T2638BN
Giza

T2670BN
Arkansas

CARATTERISTICHE

Classe di abrasione AC4. Classe di utilizzo: 23 - utilizzo domestico, intenso; 32 - utilizzo commerciale, normale. Garantito 20 anni. Bordo bisellato su 4 lati, certificato al fuoco Cfl-s1, eco-friendly, emissioni in aria interna (VOC A+) Classe A+, adatto al riscaldamento a pavimento.

I pavimenti Exclusive 5G hanno una superficie estremamente resistente, sia per uso domestico che commerciale, garanzia di 20 anni, certificati al fuoco, utilizzabili su riscaldamento a pavimento.

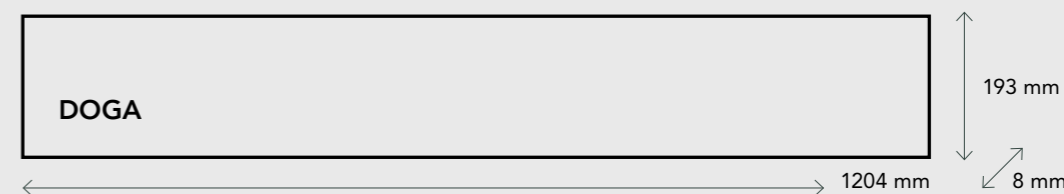
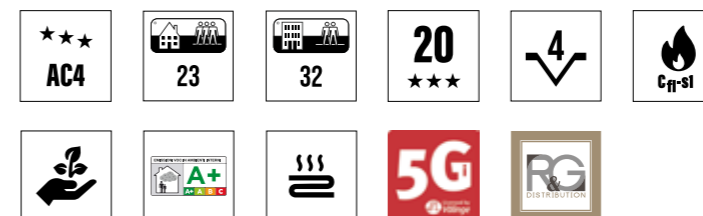

DECORI

10 VARIANTI



T2643
Retro Silver



PRK103
Acacia



PRK110
Verona

BELLA NEO

PAVIMENTI IN LAMINATO
(HDF)





PRK103
Acacia



PRK108
Daphne



PRK105
Fresia



PRK110
Verona

BELLA NEO	PAVIMENTI IN LAMINATO (HDF)	BATTISCOPIA COORDINATO (MDF)
Dimensioni	1200 mm x 191 mm	2800 mm x 80 mm
Spessore	8 mm	16 mm
Confezione	2,29 mq	
Pedana	109,92 mq	



PRK108
Daphne



PRK105
Fresia

CARATTERISTICHE

Classe di abrasione AC3. Classe di utilizzo: 23 - utilizzo domestico, intenso; 31 - utilizzo commerciale, moderato. Garantito 15 anni. A.B.C. anti-bacterial coating, certificato al fuoco Cfl-s1, eco-friendly, emissioni in aria interna (VOC A+) Classe A+, adatto al riscaldamento a pavimento.

La nostra gamma "Bella Neo", offre un nuovo livello di realismo.
La superficie opaca dona al vostro pavimento un aspetto naturale e realistico.



DECORI 4 VARIANTI

BATTISCOPA
COORDINATO

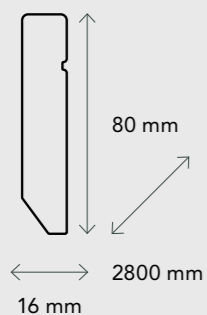

8536BN
Acacia

8563BN
Daphne

8545BN
Fresia

8534BN
Verona

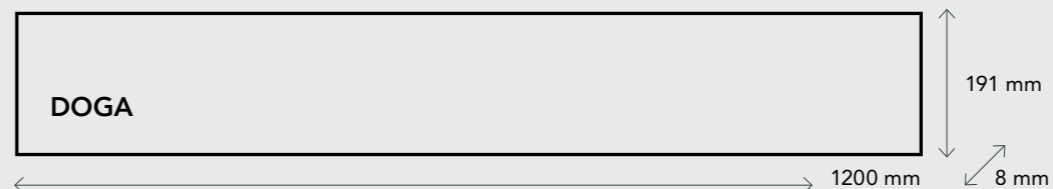

ACCESSORI

Battiscopa coordinato
in MDF



MDF

RIVESTIMENTI MURALI
(MDF)



LB3821-735
Soft Touch Relax Green

SHAPE

RIVESTIMENTI MURALI
(MDF)



LB2050-726
Matt Soft Touch Storm Grey

Rivestimenti murali Shape

LB2050

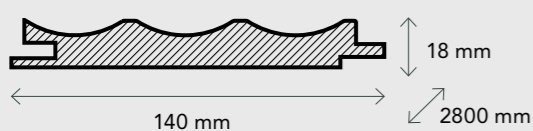

Dimensioni (mm)	18x140x2800
pz/cf	4
m ² /cf	1,57



LB2050-000
Grezzo

LB2050-726
Matt Soft Touch
Storm Grey

LB2050-735
Matt Soft Touch
Relax Green



LB2050-3029
Supramat
Glamorous Pacific

LB2050-734
Soft Touch
White

DECORI 5 VARIANTI



LB2050-735
Matt Soft Touch Relax Green



LB2050-3029
Supramat Glamorous Pacific



LB2200-248
Teak

Rivestimenti murali Shape

LB2200

Dimensioni (mm)	18x100x2800
pz/cf	6
m ² /cf	1,68

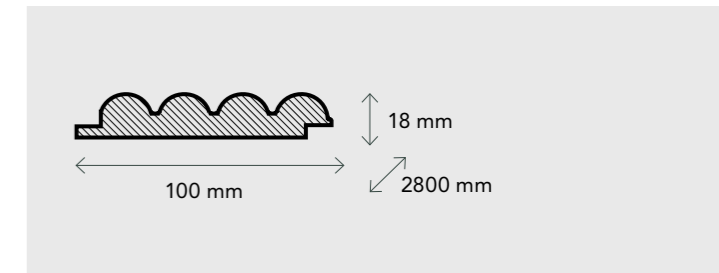

DECORI
2 VARIANTI



LB2200-248
Teak

LB2200-000
Grezzo



LB2200-248
Teak

Rivestimenti murali Shape

LB3821

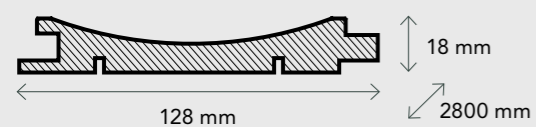

Dimensioni (mm)	18x128x2800
pz/cf	6
m ² /cf	2,15



LB3821-000
Grezzo

LB3821-726
Matt Soft Touch
Storm Grey

LB3821-735
Matt Soft Touch
Relax Green



LB3821-3029
Supramat
Glamorous Pacific

LB3821-734
Soft Touch
White

DECORI
5 VARIANTI



LB3821-726
Matt Soft Touch Storm Grey



LB3821-3029
Supramat Glamorous Pacific



LB3771-3041
Peru Oak



LB3771-397
Natural Touch Oak

Rivestimenti murali Shape

LB3771

Dimensioni (mm)	18x121x2800
pz/cf	4
m ² /cf	1,35

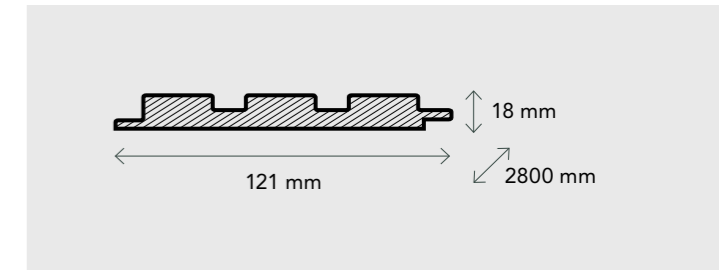

DECORI
6 VARIANTI



LB3771-000
Grezzo

LB3771-248
Teak

LB3771-3041
Peru Oak



LB3771-397
Natural Touch Oak

LB3771-3037
Texas Oak

LB3771-734
Soft Touch White

Profili Shape

LB3771-A SINISTRO

Dimensioni (mm) 18x35x2800

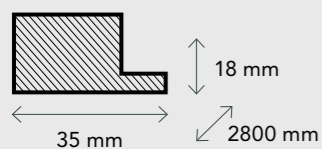

LB3771-A-000
Grezzo



LB3771-A-3041
Peru Oak



LB3771-A-3037
Texas Oak



LB3771-A-248
Teak



LB3771-A-397
Natural Touch
Oak



LB3771-A-734
Soft Touch
White

DECORI
6 VARIANTI

Profili Shape

LB3771-B DESTRO

Dimensioni (mm) 18x38x2800

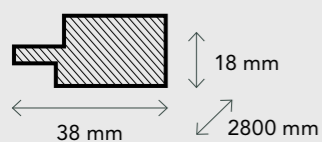

LB3771-B-000
Grezzo



LB3771-B-3041
Peru Oak



LB3771-B-3037
Texas Oak



LB3771-B-248
Teak



LB3771-B-397
Natural Touch
Oak



LB3771-B-734
Soft Touch
White

DECORI
6 VARIANTI



LB3771-248
Teak



LB3771-397
Natural Touch Oak

Rivestimenti murali Shape

ALTRI DECORI (su ordinazione minima 30 m², consegna c. 60 giorni)

1. Group

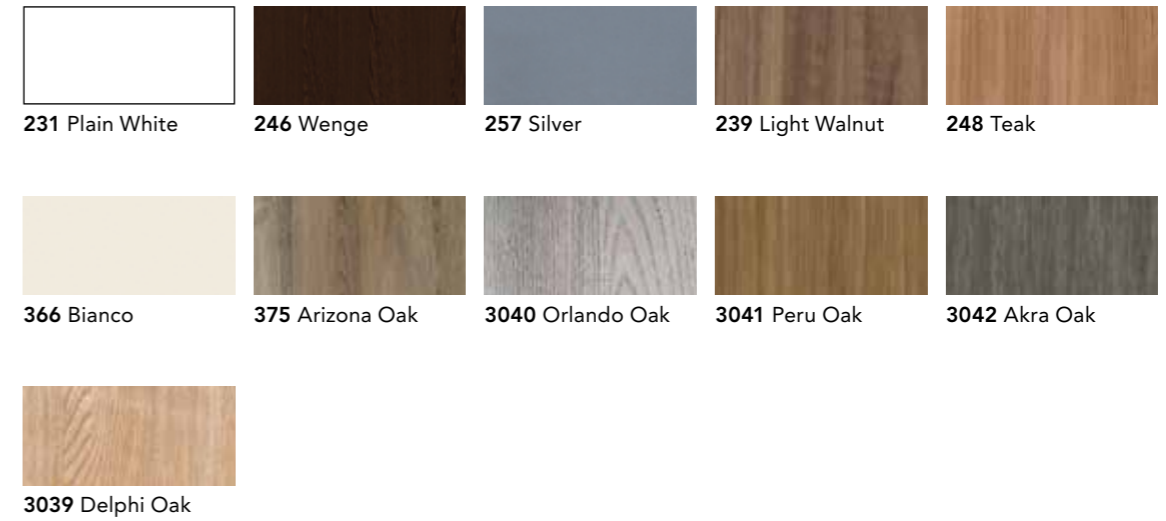

2. Group

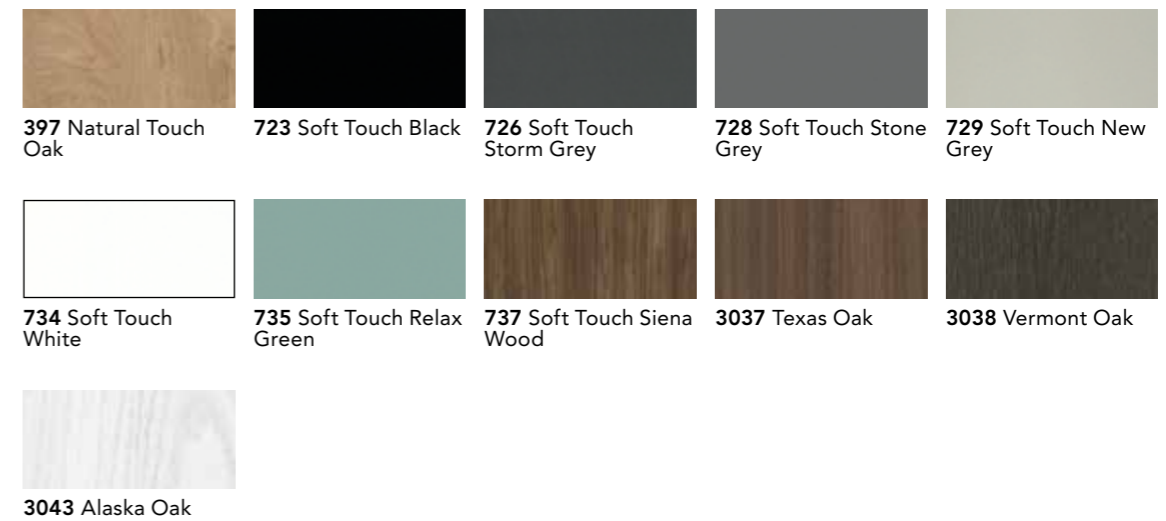

Supramat





3D WALL

RIVESTIMENTI MURALI
(MDF)



K035W
Crosstown Traffic

3D WALL	RIVESTIMENTI MURALI (MDF)
Dimensioni	1296 mm x 132 mm
Spessore	12 mm
Confezione	1,37 mq



K035W
Crosstown Traffic



K047W
Mountain Hut Pine



Il decoro K047W Mountain Hut Pine ha tre tonalità differenti in ogni confezione



K047W
Mountain Hut Pine



K047W
Mountain Hut Pine



K047W
Mountain Hut Pine



K060W
Alabaster Barnwood



K061W
Rusty Barnwood



8475W
Mustang Slate



K061W
Rusty Barnwood



K061W
Rusty Barnwood



K060W
Alabaster Barnwood



8475W
Mustang Slate

LA DECORAZIONE PERFETTA PER OGNI PARETE

3 TECNICHE DI INSTALLAZIONE
Stile autentico, diverse tecniche di
installazione: uniforme, sfalsata o irregolare.

ACCESSORI

Elementi di fissaggio e finitura per Sistema 3D Wall

K047W
Mountain Hut Pine

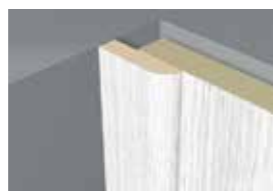

PROFILO DI FINITURA (MDF) PIATTO

Codice K035PP - Crosstown Traffic
K047PP - Mountain Hut Pine
K060PP - Alabaster Barnwood
K061PP - Rusty Barnwood
8475PP - Mustang Slate

Dimensioni 6 x 25 x 2600 mm



PROFILO DI FINITURA (MDF) AD ANGOLO ESTERNO

Codice K035PAE - Crosstown Traffic
K047PAE - Mountain Hut Pine
K060PAE - Alabaster Barnwood
K061PAE - Rusty Barnwood
8475PAE - Mustang Slate

Dimensioni 22 x 42 x 2600 mm



PROFILO DI FINITURA (MDF) AD ANGOLO VARIABILE

Codice K035PAV - Crosstown Traffic
K047PAV - Mountain Hut Pine
K060PAV - Alabaster Barnwood
K061PAV - Rusty Barnwood
8475PAV - Mustang Slate

Dimensioni 22 x 22 x 2600 mm



CLIP DI FISSAGGIO (ACCIAIO ZINCATO)

Codice 3DCLIP
Incidenza teorica 1 confezione per 5 mq
Confezione 100 pz



K061W
Rusty Barnwood

CARATTERISTICHE

Antimacchia e facile da pulire, effetto autentico, emissioni in aria interna (VOC A+) Classe A+, resistente all'acqua, resistente alla luce. Krono Original.

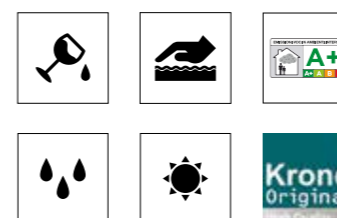

kronospaam



DECORI 5 VARIANTI

CLIP
DI FISSAGGIO

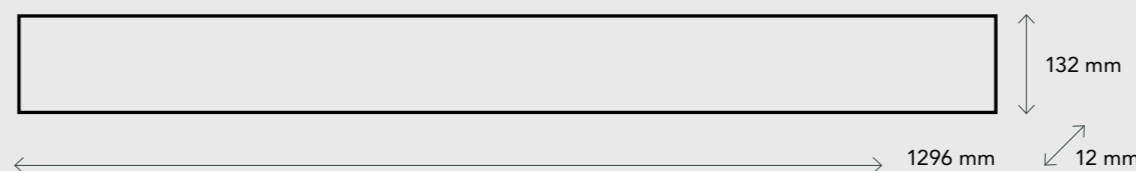
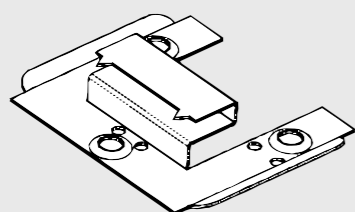

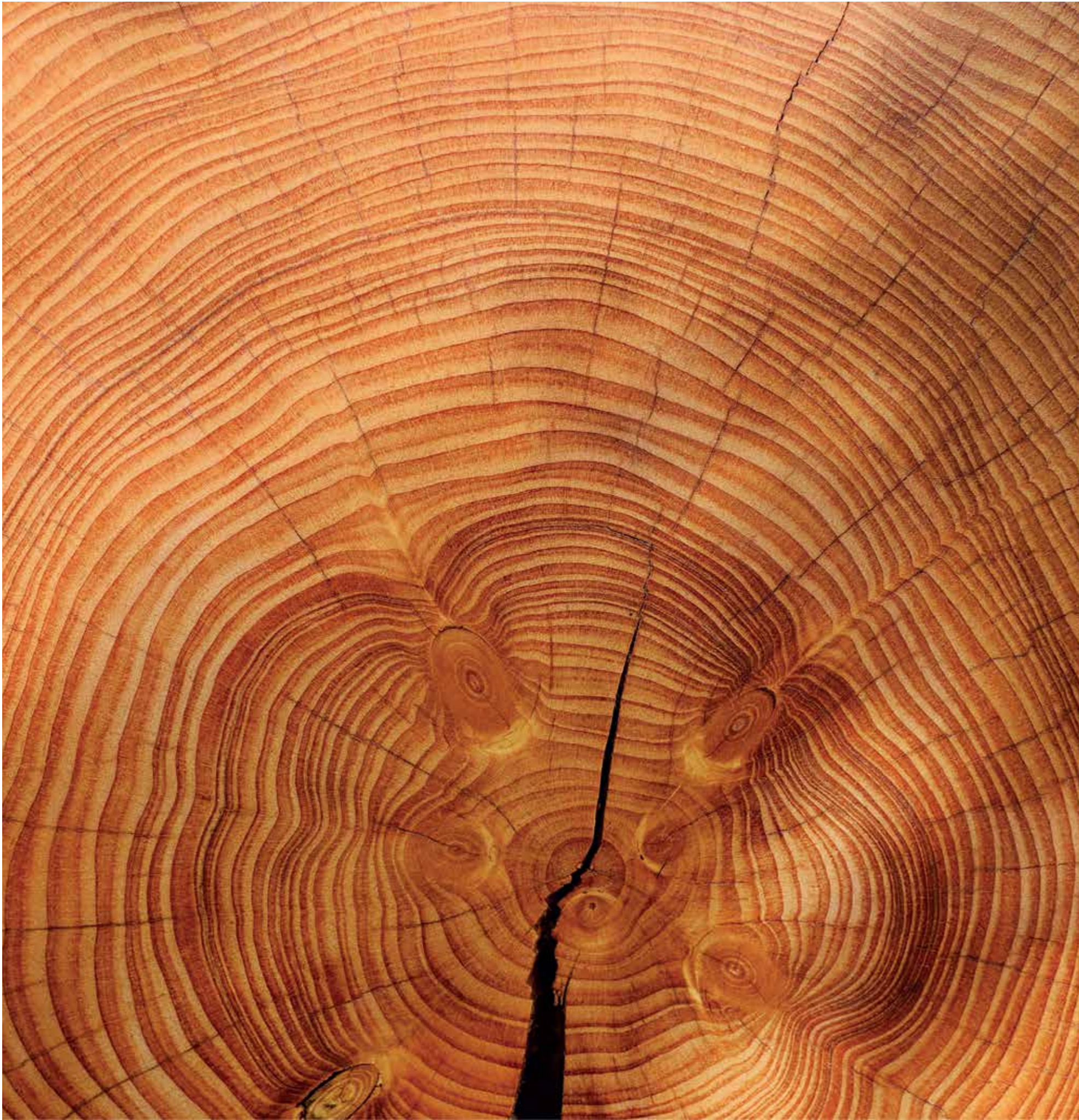

ACCESSORI DI FINITURA

BATTISCOPIA IN LEGNO LACCATO

BATTISCOPIA IN NOCE TANGANIKAI
LACCATI IN BIANCO

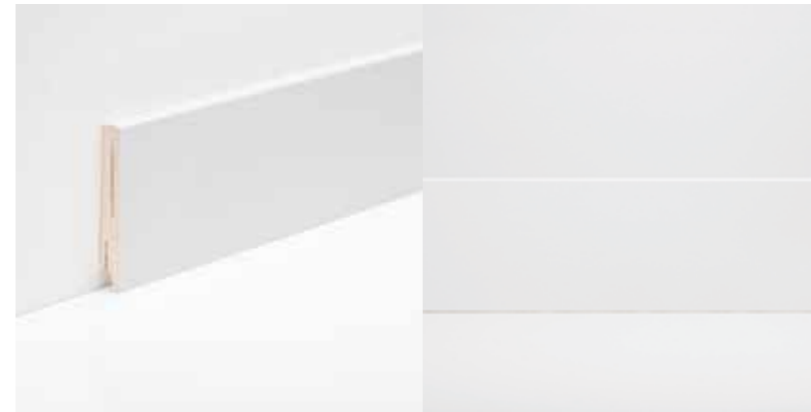

0183BN
Bianco

Dimensioni	2400 mm x 80 mm
Spessore	13 mm

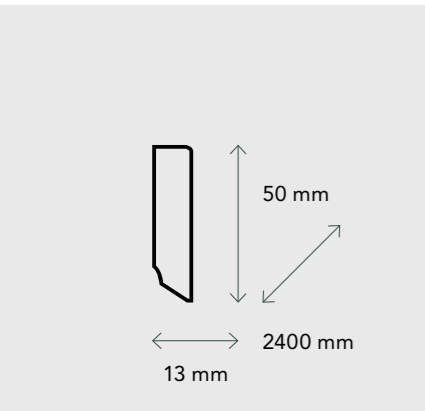
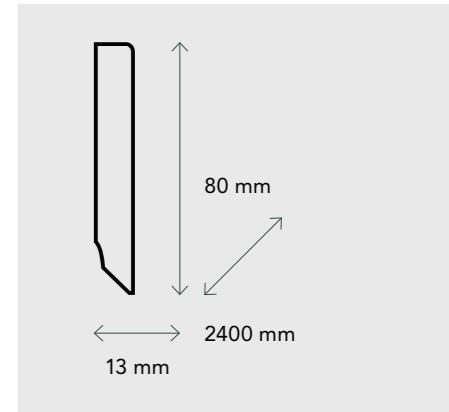

B048A
Bianco

Dimensioni	2400 mm x 50 mm
Spessore	13 mm

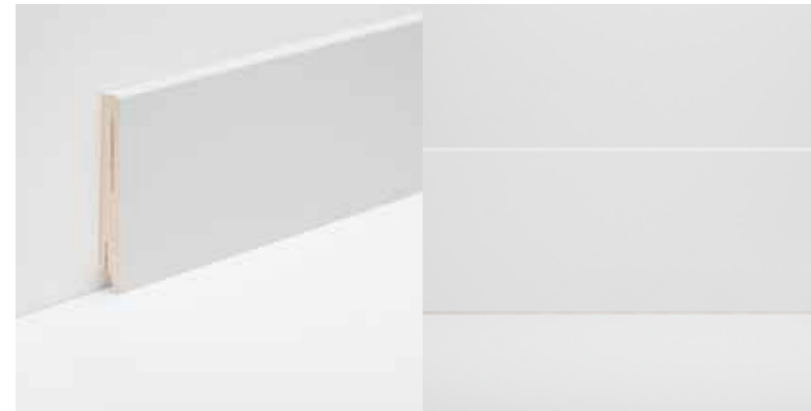

0182BN
Bianco

Dimensioni	2400 mm x 100 mm
Spessore	13 mm

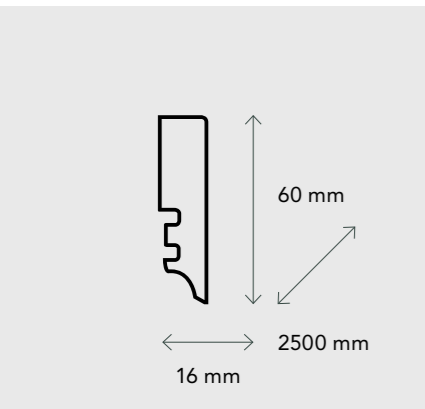
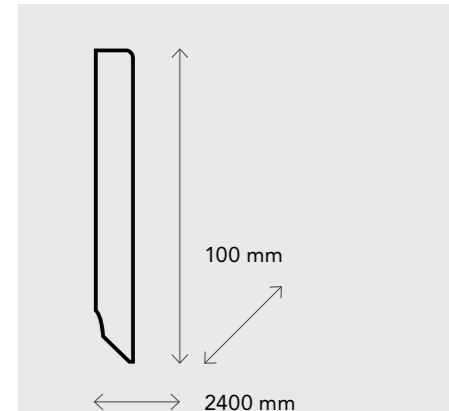

B063C
Bianco

Dimensioni	2500 mm x 60 mm
Spessore	16 mm



B515H
Bianco

Dimensioni	2400 mm x 80 mm
Spessore	13 mm

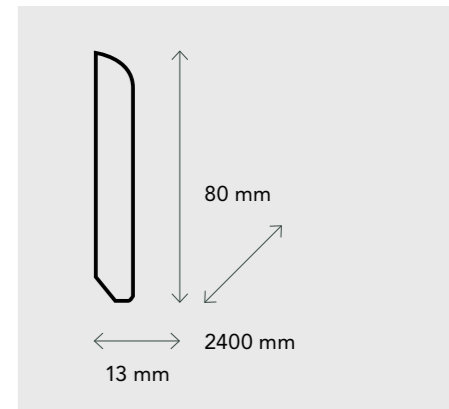

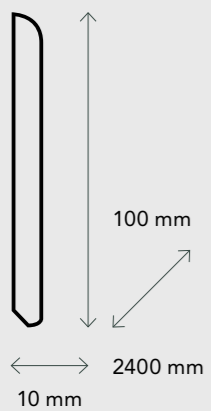

B900N
Bianco

Dimensioni 2400 mm x 100 mm
Spessore 10 mm



0184BN
Ducale Bianco laccato su Ayous

Dimensioni 2400 mm x 140 mm
Spessore 15 mm

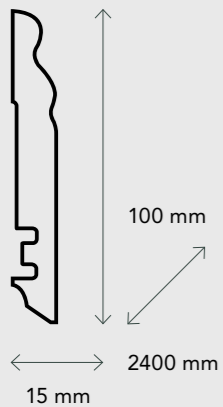
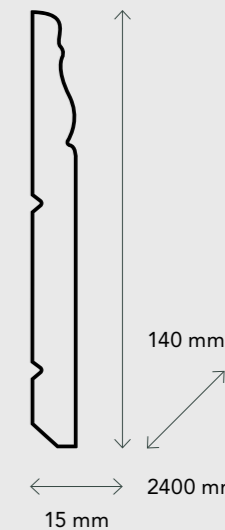

B826M240
Ducale Bianco

Dimensioni 2400 mm x 100 mm
Spessore 15 mm

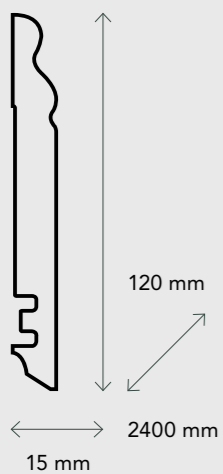

B9260240
Ducale Bianco

Dimensioni 2400 mm x 120 mm
Spessore 15 mm

BATTISCOPIA IN MDF/PVC RIVESTITI

RIVESTITI CON CARTA DECORATIVA
IN DIFFERENTI COLORAZIONI



9002S70
Vittoriano H70

Dimensioni	2600 mm x 70 mm
Spessore	17 mm

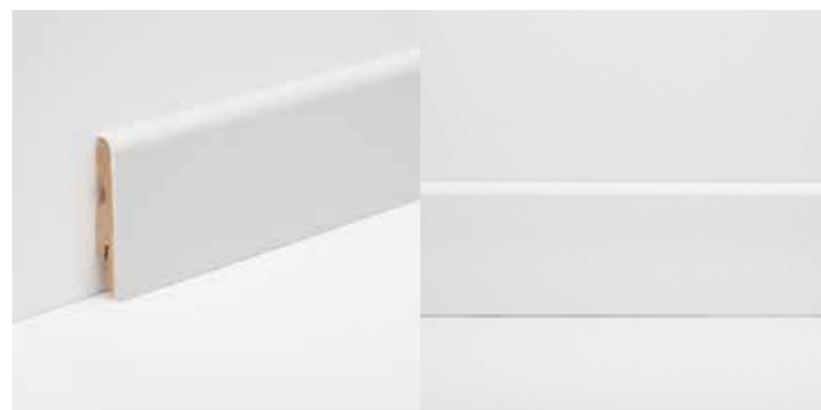
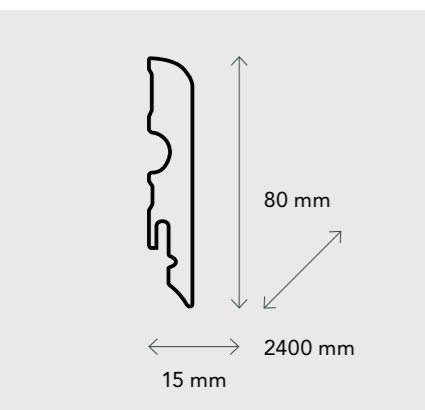
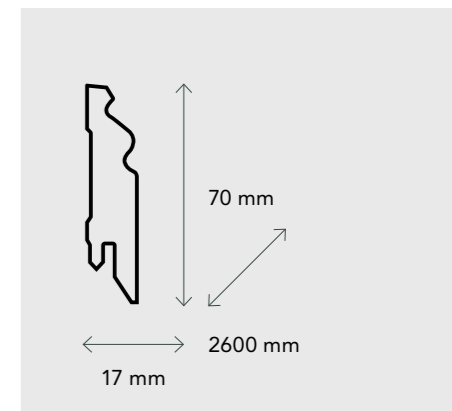

0177N
Bianco Laccato

Dimensioni	2400 mm x 80 mm
Spessore	15 mm



9002S100
Vittoriano H100

Dimensioni	2600 mm x 100 mm
Spessore	17 mm

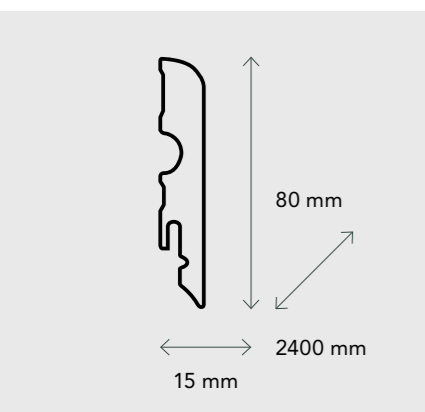
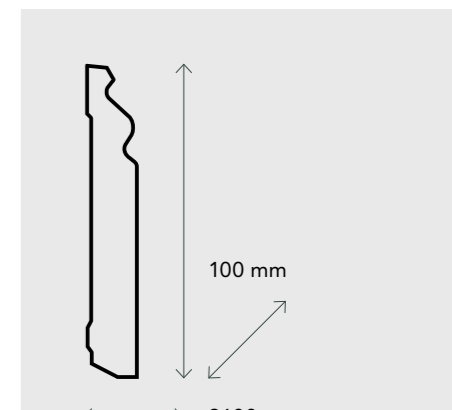

0178N
Alluminio

Dimensioni	2400 mm x 80 mm
Spessore	15 mm



K120
Vittoriano H120

Dimensioni	2600 mm x 120 mm
Spessore	19 mm

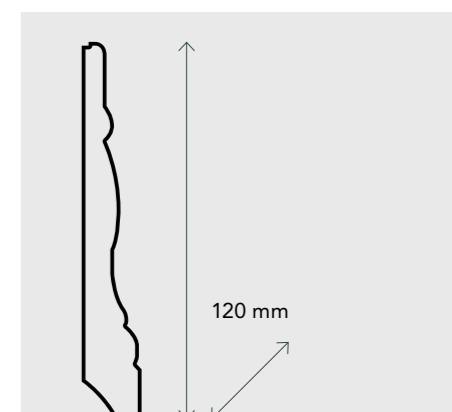

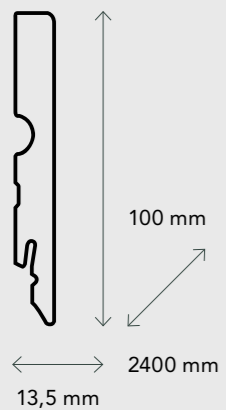

FU124L
Bianco

Dimensioni	2400 mm x 100 mm
Spessore	13,5 mm

COPRI-BATTISCOPIA IN MDF

IN DIFFERENTI COLORAZIONI
IDEALI PER RIVESTIRE BATTISCOPIA IN CERAMICA (H 70 mm)

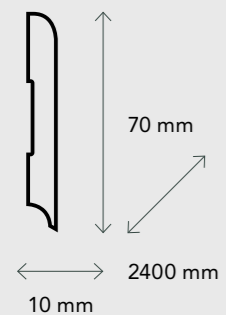

0179BND
PVC Solido Bianco

Dimensioni	2400 mm x 70 mm
Spessore	10 mm



LLF003
Bianco

Dimensioni	2400 mm x 92 mm
Spessore	24 mm

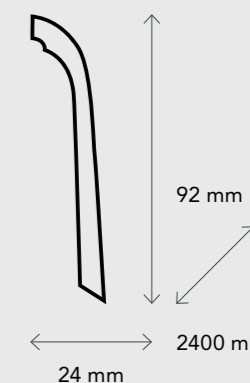

FOES015
Rovere

Dimensioni	2400 mm x 92 mm
Spessore	24 mm

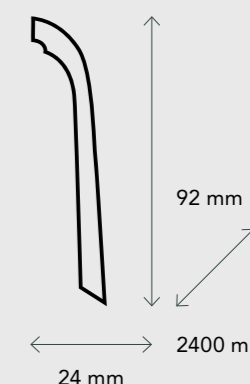

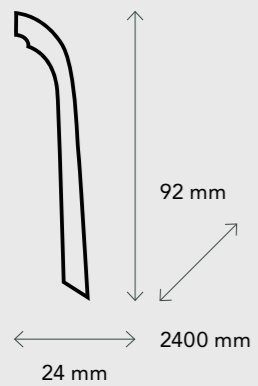

FOEI04Z
Rovere Boulder

Dimensioni	2400 mm x 92 mm
Spessore	24 mm



FOEI062
Rovere Naturale

Dimensioni	2400 mm x 92 mm
Spessore	24 mm

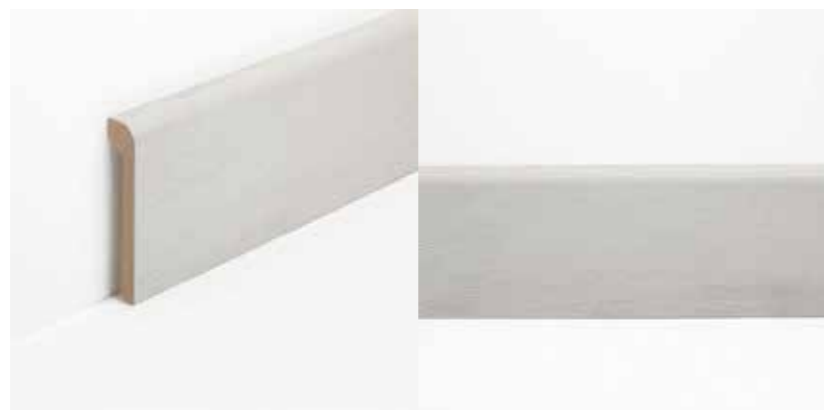
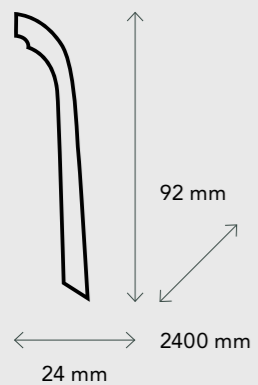
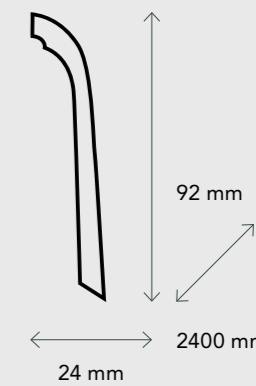

FOEI05Y
Frassino Scandinavo

Dimensioni	2400 mm x 92 mm
Spessore	24 mm

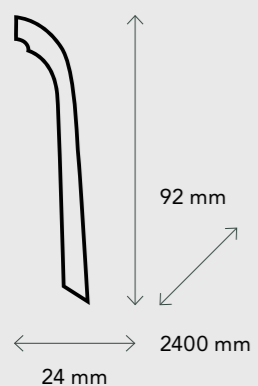

FOEI07L
Rovere Baronale

Dimensioni	2400 mm x 92 mm
Spessore	24 mm

PROFILI PER PAVIMENTI IN LAMINATO (HDF)

PROFILI CON BASE IN ALLUMINIO RIVESTITI CON CARTE DIGITALI CON PORO EFFETTO LEGNO AD ALTA RESISTENZA ALL'ABRASIONE IN DIFFERENTI COLORAZIONI

PROFILO DI ADATTAMENTO COMPLETO DI BASE IN ALLUMINIO

Codice	SARGS	
Colore	Alluminio satinato	Decori pavimenti in HDF
Dimensioni	2700 mm x 38 mm	2700 mm x 38 mm
Spessore	6-12,5 mm	6-12,5 mm



PROFILO MULTIFUNZIONE (ADATTAMENTO/RACCORDO/TERMINALE)

Codice	MS27	
Colore	Alluminio	
Dimensioni	2700 mm x 37 mm	
Spessore		

PROFILO DI RACCORDO COMPLETO DI BASE IN ALLUMINIO

Codice	RARGS	
Colore	Alluminio satinato	Decori pavimenti in HDF
Dimensioni	2700 mm x 38 mm	2700 mm x 38 mm
Spessore	6-12,5 mm	6-12,5 mm

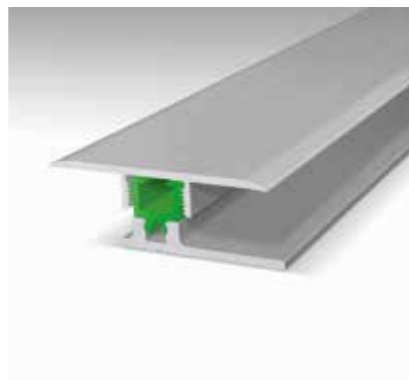

PROFILO MULTIFUNZIONE (ADATTAMENTO/RACCORDO/TERMINALE)

Codice	MB27	
Colore	Bronzo	
Dimensioni	2700 mm x 37 mm	
Spessore		

PROFILO TERMINALE COMPLETO DI BASE IN ALLUMINIO

Codice	TARGS	
Colore	Alluminio satinato	
Dimensioni	2700 mm x 38 mm	
Spessore	6-12,5 mm	

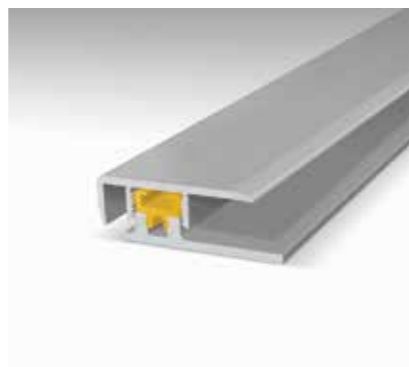

PROFILO MULTIFUNZIONE (ADATTAMENTO/RACCORDO/TERMINALE)

Codice	MG27	
Colore	Oro	
Dimensioni	2700 mm x 37 mm	
Spessore		

PROFILI SPECIALI

PER SCALE O BATTISCOPIA

PROFILO PER SCALE COMPLETO DI BASE

Codice	708357
Colore	Alluminio
Dimensioni	2400 mm x 30 mm
Spessore	7-12 mm

Profilo in alluminio completo di base per l'installazione di pavimento in laminato utilizzato per il rivestimento di gradini.

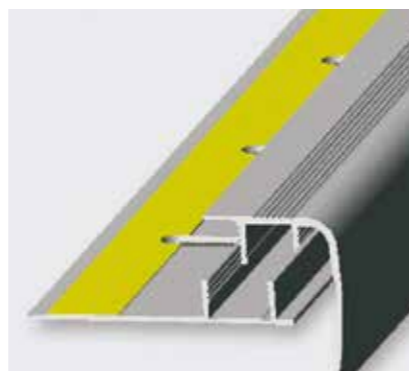

PROFILO DI SUPPORTO PER BATTISCOPIA CON INSERTO LED

Codice	713100
Colore	Alluminio satinato
Dimensioni	2400 mm (lunghezza)
Spessore	15 mm

Profilo in alluminio per battiscopa in MDF adatto ad ospitare una striscia LED. Il prezzo non è comprensivo della striscia LED.



SOTTOFONDI ISOLANTI

PER PAVIMENTI IN LAMINATO HDF-HDF O.R.C.A.

POLIETILENE AD ALTA DENSITÀ

Codice	PVCST
Dimensioni	15 m x 1 m
Spessore	2 mm
Rotolo	15 mq
Densità	100 kg/m ³
Res. Termica	0,037 m ² K/W

Polietilene ad alta densità con integrata barriera al vapore in PE. Consigliato per traffico pesante, abbinabile a pavimenti per uso residenziale e commerciale. Adatto all'uso su sistemi di riscaldamento radianti.



POLIETILENE ESPANSO

Codice	PVC30H	PVC50H	PVC135H
Dimensioni	30 m x 1 m	50 m x 1 m	135 m x 1 m
Spessore	2 mm	2 mm	2 mm
Rotolo	30 mq	50 mq	135 mq

Densità

Res. Termica

Polietilene espanso, utilizzabile come sottofondo per pavimenti in laminato.

POLIETILENE A MEDIA DENSITÀ

Codice	PVCS30
Dimensioni	25 m x 1,2 m
Spessore	2 mm
Rotolo	30 mq
Grammatura	61 g/mq
Cond. Termica	0,045 W/mk

Riduzione al rumore da calpestio 19 dB

Polietilene a media densità con integrata barriera al vapore metallizzata, cmosa sbordante per una posa veloce, alta capacità di compensazione puntuale. Adatto all'uso su sistemi di riscaldamento radianti.



POLIETILENE ESPANSO

Codice	PVC50H3	PVC150H3
Dimensioni	50 m x 1 m	150 m x 1 m
Spessore	3 mm	3 mm
Rotolo	50 mq	150 mq

Densità

Res. Termica

Polietilene espanso, utilizzabile come sottofondo per pavimenti in laminato.

POLIETILENE ESPANSO AD ALTA DENSITÀ

Codice	PVC50P3
Dimensioni	50 m x 1 m
Spessore	3 mm
Rotolo	50 mq
Densità	80 kg/m ³
Res. Termica	

Polietilene espanso ad alta densità, utilizzabile come sottofondo per pavimenti in laminato.



LEGENDA CARATTERISTICHE

COLLEZIONE	A.B.C. ANTI-BACTERIAL COATING	ANTIBATTERICO	ANTIGRAFFIO	ANTIMACCHIA E FACILE DA PULIRE	ANTISTATICO	BORDO BISELLATO SU 4 LATI	CERTIFICATO AL FUOCO	CLASSE DI ABRASIONE	CLASSE DI UTILIZZO	ECO-FRIENDLY
------------	----------------------------------	---------------	-------------	-----------------------------------	-------------	------------------------------	-------------------------	---------------------	--------------------	--------------

CARATTERISTICHE

PAVIMENTI IN LAMINATO AD ALTA RESISTENZA (HDF O.R.C.A.)

BIONYL PRO								
---------------	--	--	--	--	--	--	--	--

PAVIMENTI IN LAMINATO (HDF MO.RE!)

ALTITUDE COLLECTION								
------------------------	--	--	--	--	--	--	--	--

PAVIMENTI IN LAMINATO (HDF)

VINTAGE CLASSIC							
--------------------	--	--	--	--	--	--	--

MOOD							
------	--	--	--	--	--	--	--

NATURA AC5							
---------------	--	--	--	--	--	--	--

EXCLUSIVE 5G						
-----------------	--	--	--	--	--	--

BELLA NEO				
--------------	--	--	--	--

RIVESTIMENTI MURALI (MDF)

SHAPE

3D WALL	
---------	--

EFFETTO AUTENTICO	EFFETTO PIALLATO A MANO	EMISSIONI IN ARIA INTERNA (VOC A+)	GARANZIA	INSTALLAZIONE	ORGANIC RIGID BOARD	PET FRIENDLY	RESISTENTE ALLA LUCE	RESISTENTE ALL'ACQUA	RISCALDAMENTO A PAVIMENTO	STRATO DI USURA	MARCHI DI FABBRICA
----------------------	----------------------------	---------------------------------------	----------	---------------	---------------------	--------------	----------------------	----------------------	------------------------------	-----------------	--------------------

CARATTERISTICHE

PAVIMENTI IN LAMINATO AD ALTA RESISTENZA (HDF O.R.C.A.)

--	--	--	--	--	--	--	--	--	--

PAVIMENTI IN LAMINATO (HDF MO.RE!)

--	--	--	--	--	--	--	--

PAVIMENTI IN LAMINATO (HDF)

--	--	--	--	--	--	--

--	--	--	--	--	--

--	--	--	--

--	--	--	--	--













--	--	--	--





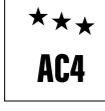



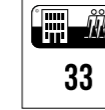

RIVESTIMENTI MURALI (MDF)

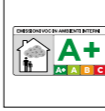
SHAPE

--	--	--	--	--

LEGENDA ICONE

	A.B.C. ANTI-BACTERIAL COATING Le superfici di tutti i nostri pavimenti in laminato presentano un rivestimento antibatterico che inibisce la crescita dei batteri e rilascia una maggiore garanzia alla pulizia dei vostri ambienti (germi testati: Staphylococcus aureus).			
	ANTIBATTERICO			
	ANTIGRAFFIO La robusta superficie protegge contro i micrograffi che possono essere causati da forti sollecitazioni meccaniche come mobili in movimento, oggetti che cadono o artigli di animali domestici.			
	ANTIMACCHIA E FACILE DA PULIRE Bassa manutenzione.			
	ANTISTATICO Non crea carica elettrica statica nel caso di attrito, a differenza di molte tipologie di pavimenti in laminato. Nessuna scossa elettrica indesiderata.			
	BORDO BISELLATO SU 4 LATI Aspetto naturale grazie al bordo bisellato sui 4 lati. Micro-bisellatura su pavimenti resilienti, bisellatura per pavimenti in laminato.			
		CERTIFICATO AL FUOCO Cfl-s1. Bfl-s1.		
			CLASSE DI ABRASIONE AC3 AC4 AC5	
				CLASSE DI UTILIZZO 23 - Utilizzo domestico, intenso. 31 - Utilizzo commerciale, moderato. 32 - Utilizzo commerciale, normale. 33 - Utilizzo commerciale, intenso.

	ECO-FRIENDLY		
	EFFETTO AUTENTICO Effetto autentico, superficie in rilievo assolutamente realistica, fedele al vero, appare reale.		
	EFFETTO PIALLATO A MANO		
	EMISSIONI IN ARIA INTERNA (VOC A+) Pavimento con classificazione VOC A+ per la qualità dell'aria negli ambienti, una dichiarazione sul livello di emissione di sostanze volatili nell'aria interna che rappresentano una minaccia tossica durante l'inalazione.		
			GARANZIA 15 - Garantito 15 anni. 20 - Garantito 20 anni. 30 - Garantito 30 anni.
		INSTALLAZIONE 1Clic 2Go Pure - Veloce, pulito e facile. 5G	
	ORGANIC RIGID BOARD Prodotto in materiale biologico (costituito da legno naturale e legante chimico biologico) e in modo ecologico, usando legname proveniente da foreste gestite in modo sostenibile (solo BionylPro).		
	PET FRIENDLY Grazie alla sua superficie antibatterica e antigraffio, è eccezionalmente adatto a resistere ai piccoli contrattempi causati dai nostri piccoli amici a quattro zampe (solo Byonil Pro).		
	RESISTENTE ALL'ACQUA Adatto all'installazione in bagni e ambienti umidi.		



RESISTENTE ALLA LUCE
Non sbiadisce.

La capacità di non sbiadire (classificata 6, la maggiore della scala) rende questo pavimento ideale per ambienti esposti a luce intensa, ad esempio giardini d'inverno o camere con finestre dal pavimento al soffitto (solo BionylPro).

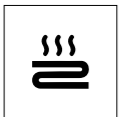

RISCALDAMENTO A PAVIMENTO
Adatto al riscaldamento a pavimento.



STRATO DI USURA
0,80 mm

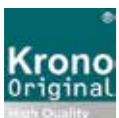

kronospan



MARCHI DI FABBRICA

Prodotto a marchio Krono Original.
Prodotto a marchio Kronospan.
Prodotto a marchio R&G Distribution.

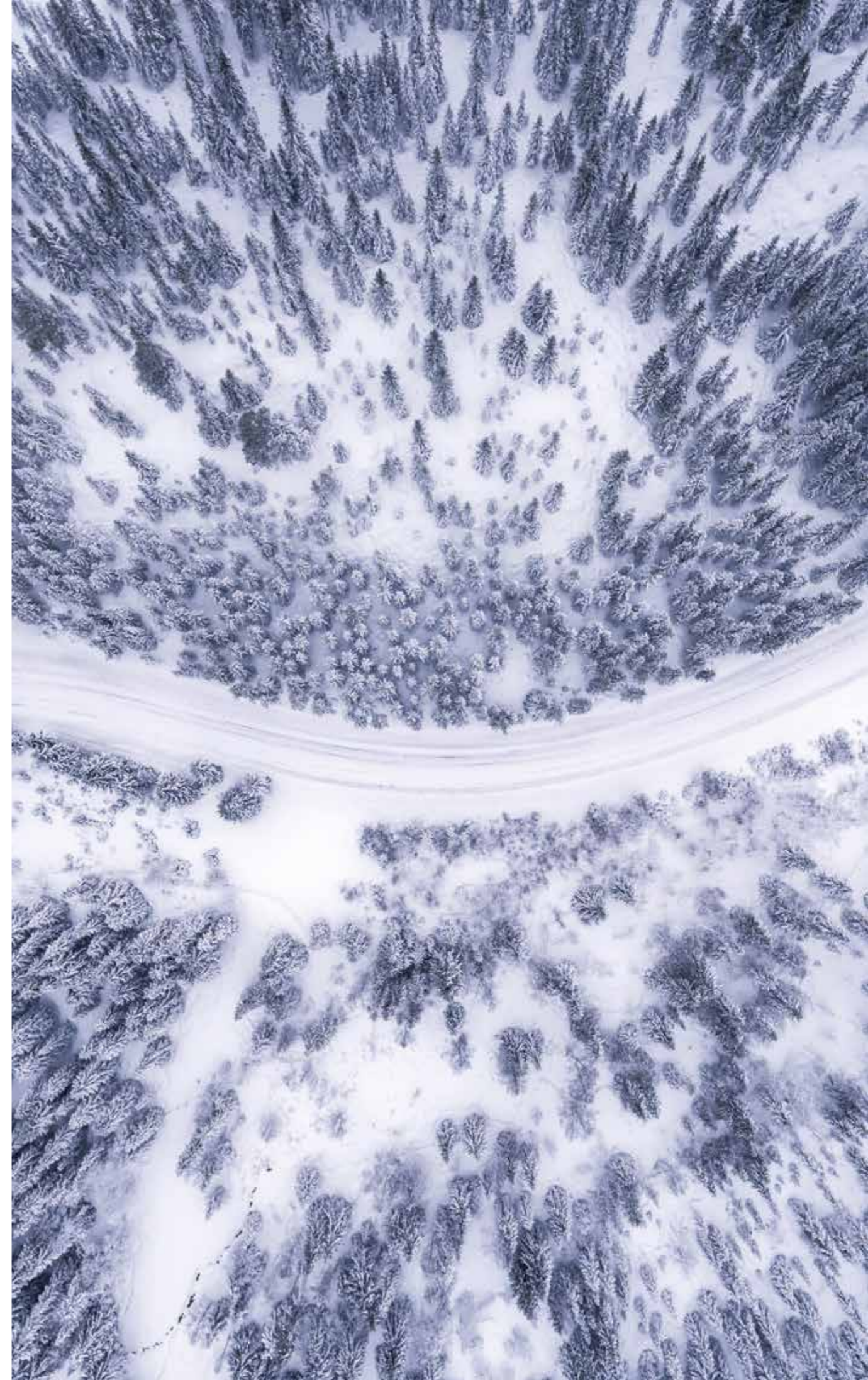

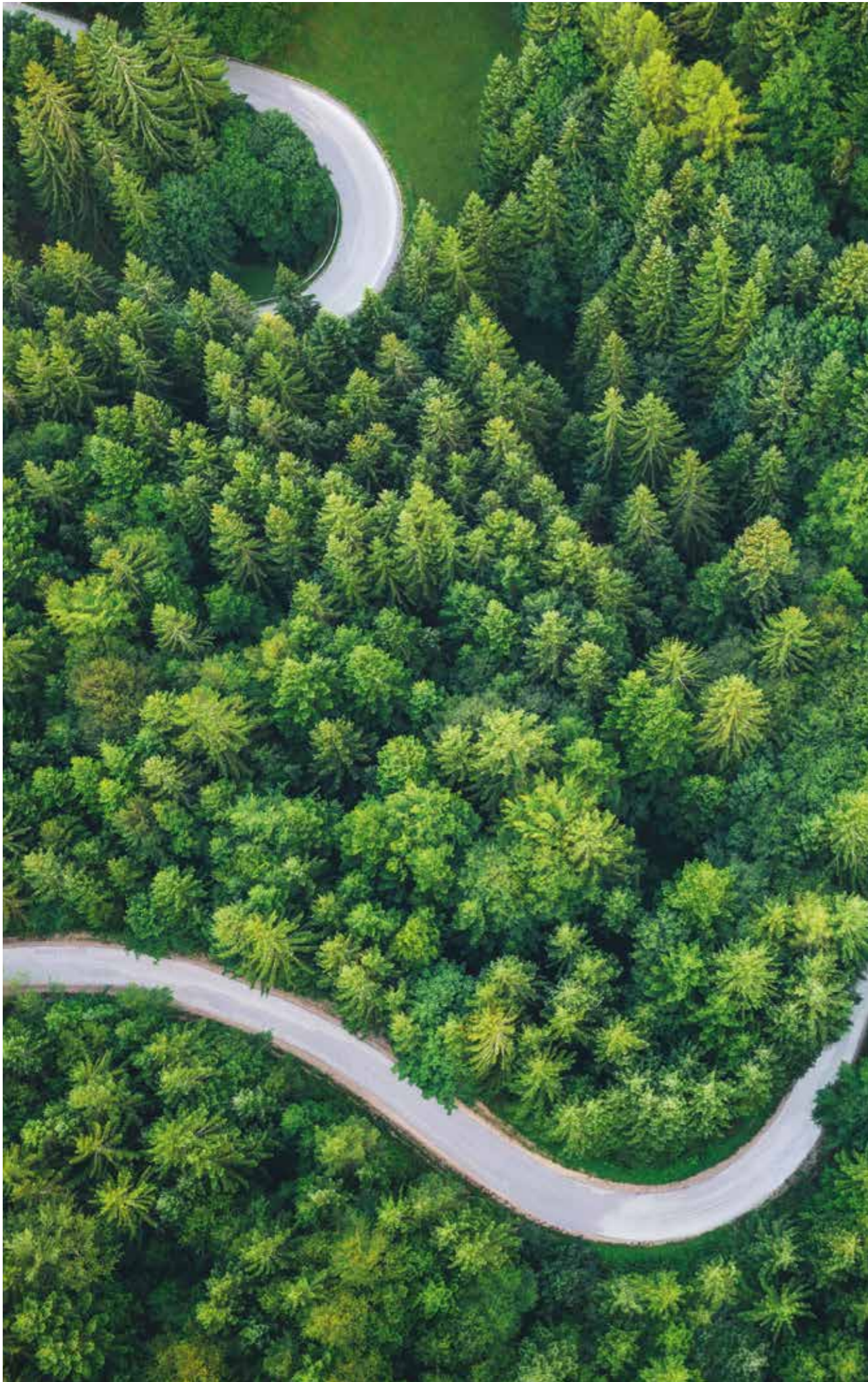

R&G DISTRIBUTION

R&G Distribution nasce nel 2008 da una cinquantennale esperienza maturata nel settore della distribuzione delle finiture d'interni. Negli ultimi anni si specializza nella distribuzione dei pavimenti flottanti in laminato, PVC e nei pavimenti tecnici per esterno.

La passione per le finiture e la lungimiranza con la quale questa attività viene esercitata, hanno reso oggi più che mai R&G Distribution un riferimento nel settore. L'attività di distribuzione viene esercitata mettendo in atto garanzie complessive che salvaguardano la qualità dei prodotti. A questo proposito si avvale della partnership delle più importanti aziende produttrici europee ed extraeuropee e di una filiera distributiva atta a soddisfare qualsiasi esigenza di servizio venga richiesta dal mercato, attraverso la collaborazione dei più importanti vettori nazionali.

I nostri prodotti uniscono eleganza, praticità e facilità di posa a costi competitivi. Sono supportati da un magazzino fornitissimo e sempre in linea con le ultime novità proposte dal mercato. A ciò si aggiunge una infinita varietà di accessori coordinati a completamento delle nostre gamme di prodotti ed offrono ai nostri clienti il vantaggio di soddisfare con un unico fornitore ogni richiesta proveniente dal mercato.

R&G Distribution, un marchio di qualità giovane e dinamico proiettato nel futuro, con solide basi create negli anni.

R&G DISTRIBUTION SRL

SEDE OPERATIVA
Via Nunzio Carretta, 2
71017 Torremaggiore (FG)
T 0882 42 08 56

info@regdistribution.com





REGDISTRIBUTION.COM